

**A**

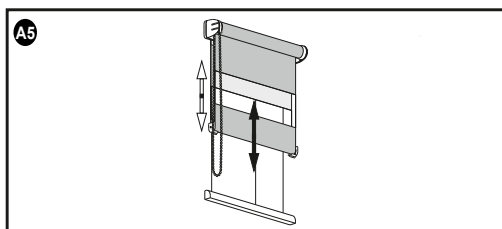

**B**

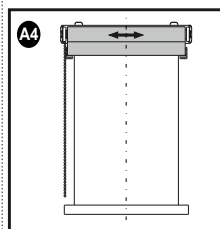

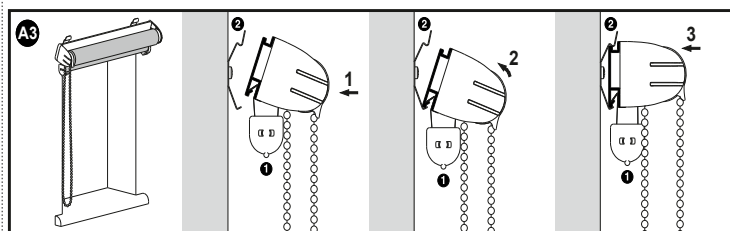
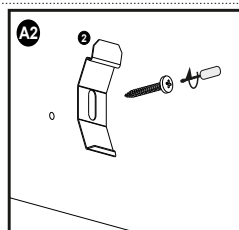
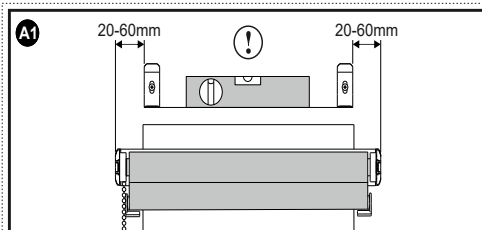
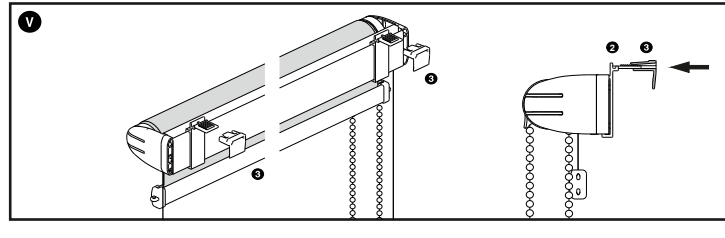
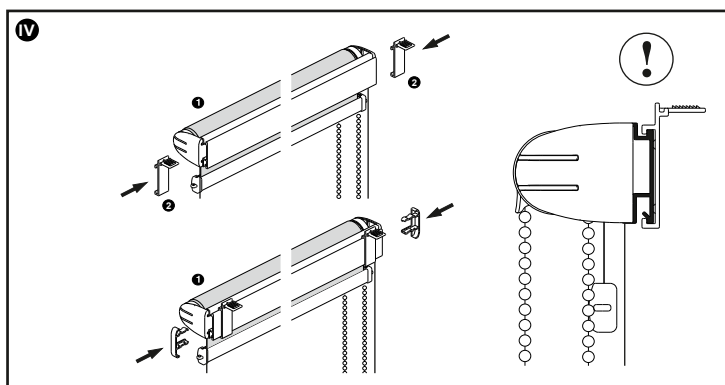
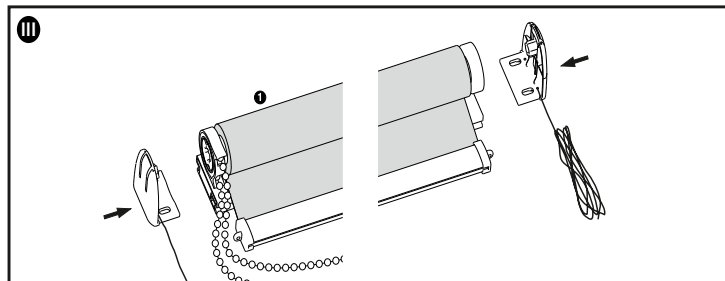
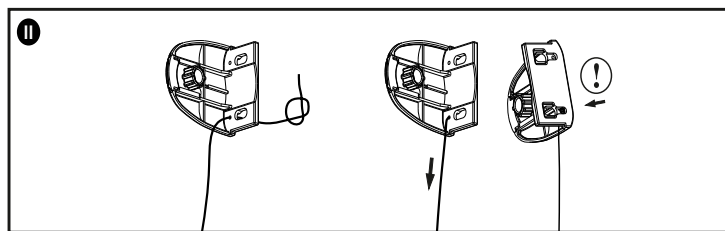
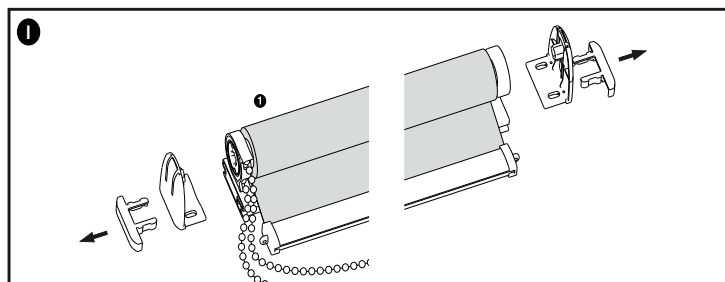
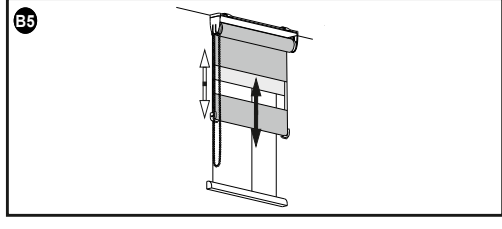
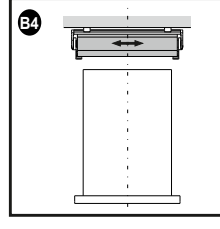
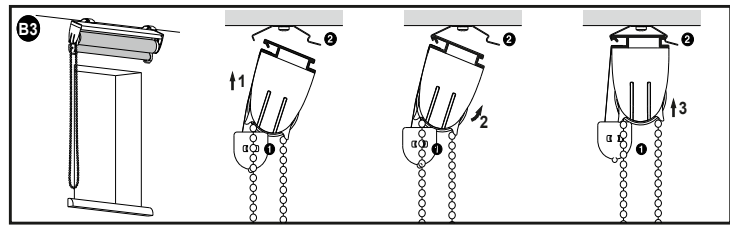
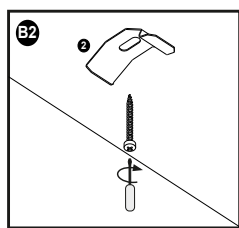
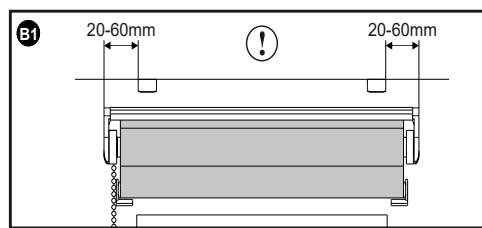
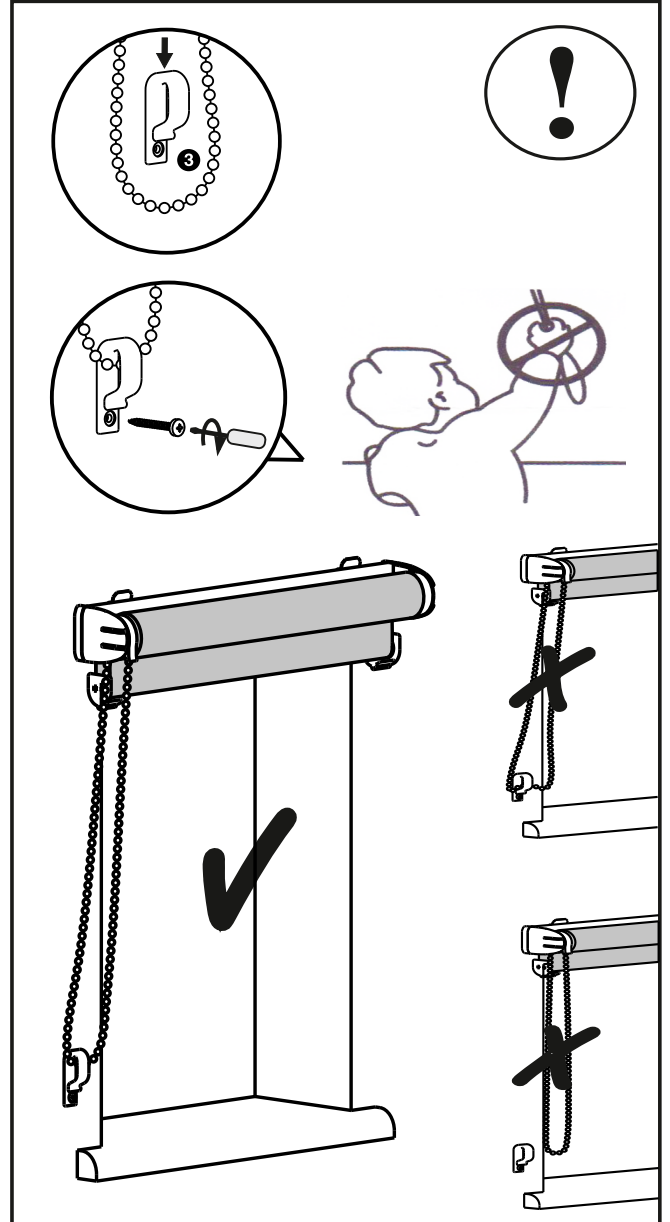
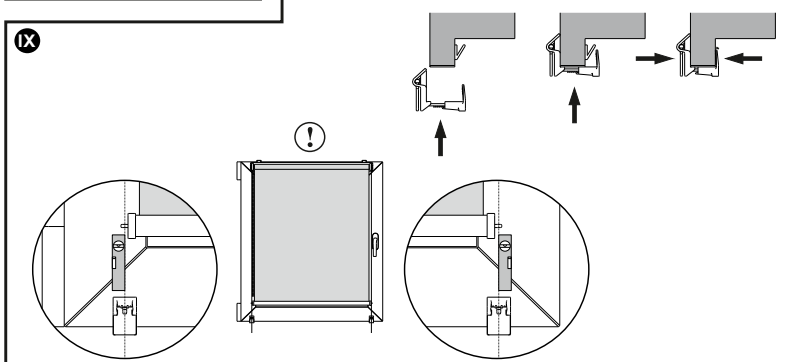
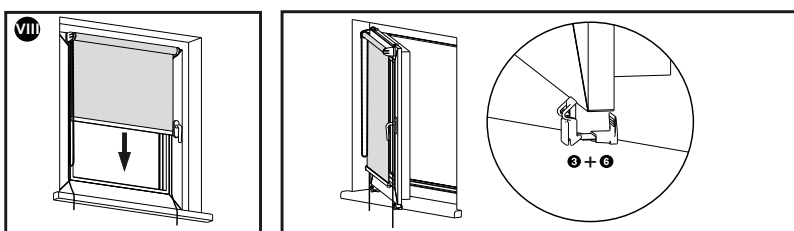
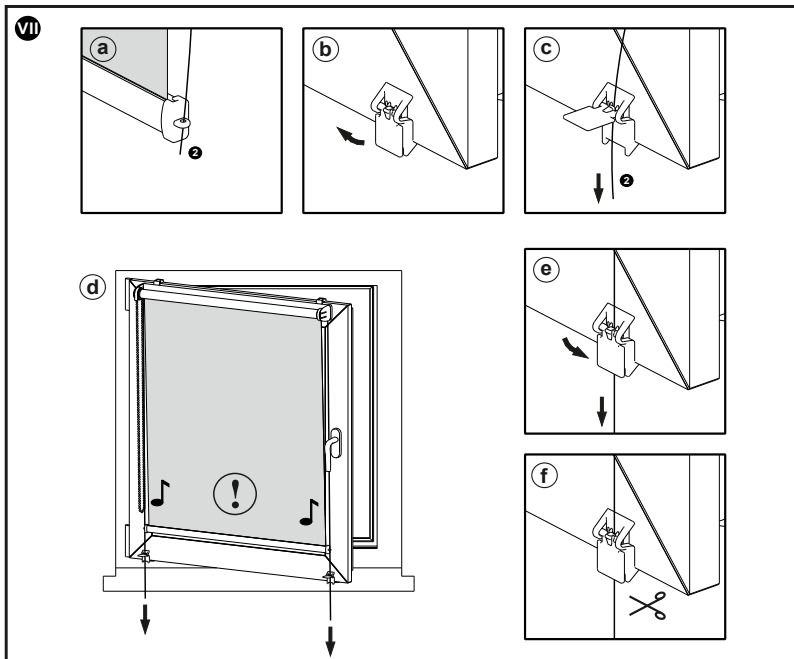
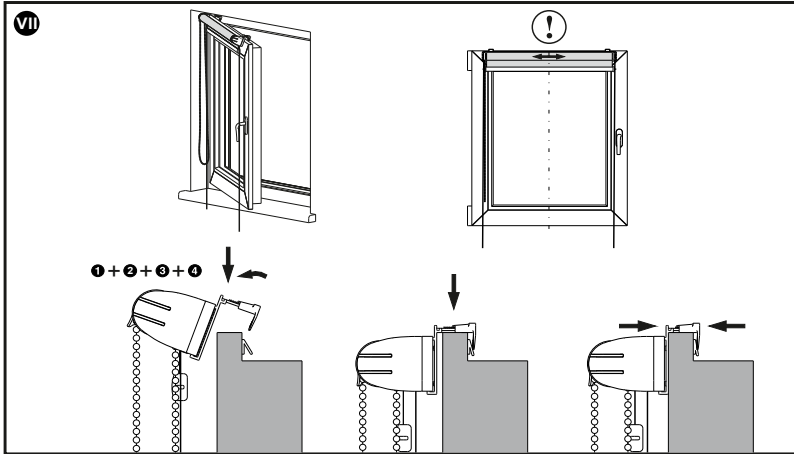
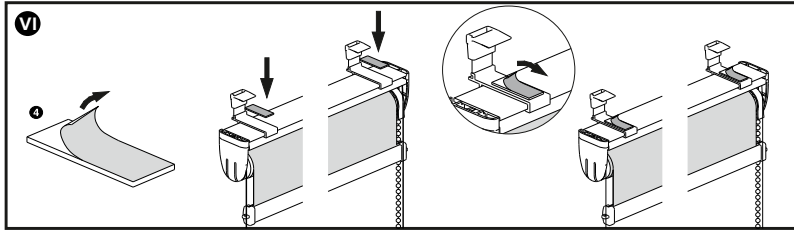

**HU:FIGYELEM!** Tilos a rolót teljesen letekerni, mert a szövet sérüléséhez vezethet! Ügyeljen arra, hogy vízszintesen szerelje fel! Ellenkező esetben ez ferde feltekeredést okozhat, mely a szerkezet károsodásához vezethet. Ne adja kisgyermek kezébe! A csomagolás apróalkatrészeket tartalmaz. A szerkezet láncát minden esetben rögzítse a lánctartóba, ellenkező esetben balesetet okozhat!

**RO:ATENȚIE!** Nu desfășurați complet rulorul deoarece acest lucru poate deteriora materialul! Asigurați-vă că îl montați orizontal. În caz contrar, poate cauza înclinare, ceea ce poate duce la deteriorarea sistemului. A nu se lăsa la îndemâna copiilor! Pachetul conține piese mici. Fixați întotdeauna șnurul sistemului în suportul de șnur, altfel poate provoca accidente!

**SK: UPOZORNENIE!** Je zakázané roletu celkom odmotáť, nakoľko to môže viesť k poškodeniu tkaniva! Dbajte na to, aby bola namontovaná vodorovne! V opačnom prípade to môže spôsobiť šikmé zrolovanie, čo môže spôsobiť poškodenie konštrukcie. Nedávajte ju malým deťom do rúk! Balenie obsahuje malé súčiastky. Retiazku konštrukcie vždy zaistite do držiaka pre retiazku, v opačnom prípade to môže spôsobiť nehodu!